

Analog Bottom Mount MEMS Microphone

IRS-3526-AB-3868

Integrating IR Sensors' advanced silicon microphones into your products significantly elevates the user experience. These microphones offer exceptional sound quality, characterized by a high signal-to-noise ratio (SNR), enhanced output sensitivity, and a low cut-off frequency. Additionally, users enjoy prolonged battery life thanks to the microphones' low power consumption, while their dustproof and waterproof design ensures increased reliability.

As a product manufacturer, you will value the microphones' compact form factor and seamless single-output integration, which allows for easy replacement of existing options. They are available in both tape & reel or tube packaging to suit your needs. With a network of global foundry partners, we minimize delivery risks and supply chain disruptions. Experience the next generation of MEMS microphones, engineered to enhance the quality and reliability of your products.

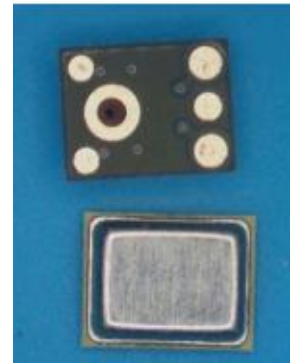

Description

The IR-3526-AB-3868 series of MEMS capacitive silicon microphones feature a patented, next-generation design tailored to meet the diverse needs of customer applications and evolving market demands. Utilizing advanced capacitive sensing technology, this platform offers an extensive signal-to-noise ratio (SNR) range from -60dB to -80dB and beyond, positioning it to comply with future microphone standards.

Our unique, patented designs and processes produce world-class microphones specifically engineered for high-volume, high-performance applications. This innovation enables an exceptional signal-to-noise ratio (SNR) in a smaller die size, allowing for compact packaging that meets the growing demand for smaller footprints in future applications.

Features

- High SNR > 67dB
- Low Noise
- Omni directional
- Small SMD package
- High sensitivity, -38dB typical
- JEDEC compatible
- Bottom & top mount
- RoHS compatible
- Low frequency roll off by design, 20 Hz, typical
- Intrinsically waterproof and dustproof
- Tape & Reel packaging or tube packaging
- Low current consumption, < 130 uA

Typical Applications

- Mobile Phones
- Audio devices
- Earphone and Earbud
- Laptop / PC / Tablet
- Automotive
- Remote Sensing
- Door Bell
- Home Automation
- Camera

Analog Bottom Mount MEMS Microphone

The Crown Jewel of MEMS microphones

The IR microphone sensor introduces groundbreaking technology that enables a reduction of up to 60% in package volume and power consumption compared to competitors, all while maintaining the same high signal-to-noise ratio (SNR). This innovation not only addresses the increasing demand for miniaturization but also enhances energy efficiency, making it the perfect solution for compact, power-sensitive applications.

IR's innovative two substrates design and fabrication

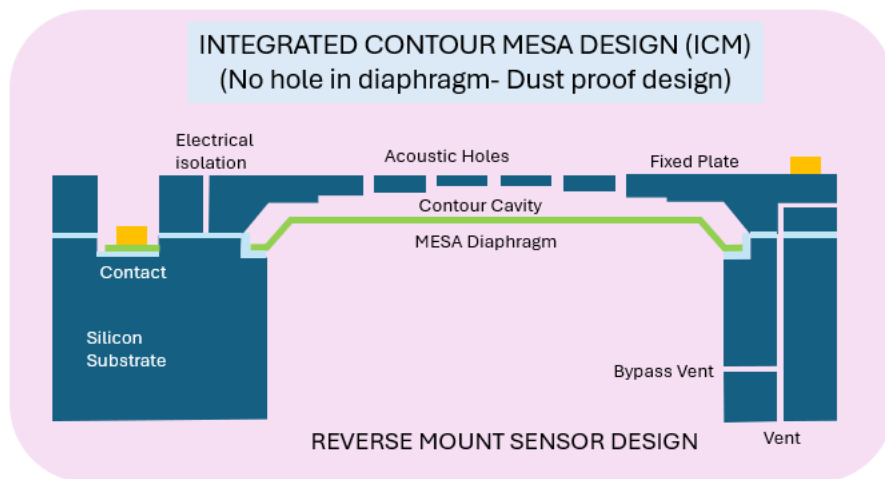

Our unique, patented technology integrates several innovative features, including a trapezoidal diaphragm design and contoured cavity, which work together to enhance sensitivity and minimize acoustic noise. This design allows the IR microphone sensor to achieve an SNR of -80dB with a single output and a compact footprint, making it perfect for high-performance applications where space is limited.

Order Information

Product ID	Package	Marking/Order Code
IR3526AB3868	MP-B-3526-68	IR02

Analog Bottom Mount MEMS Microphone

PRODUCT KEY PERFORMANCE SPECIFICATIONS

Technical Specification: All data taken at 25±2°C, Relative Humidity 45±5% unless otherwise specified.
 General Ratings Specifications

SPECIFICATION	MINIMUM	TYPICAL	MAXIMUM	UNITS
Operating Temperature	-40	-	+85	°C
Storage Temperature	-40	-	+100	°C
MSL (moisture sensitivity Level)	Class 1			

Product Key Acoustic Performance Specification

PARAMETER	SYMBOL	TEST CONDITION	VALUES			UNITS
			MIN	TYP	MAX	
Directivity			Omni-directional			
Sensitivity	S	94 dB SPL @ 1kHz	-40	-38	-36	dB V/Pa
Signal to Noise Ratio	SNR	94 dB SPL @ 1kHz, A-weighted		68		dB
Total Harmonic Distortion	THD	94 dB SPL @ 1kHz			0.1	%
Acoustic Over Pressure	AOP	10% THD @ 1kHz		>130		dB SPL
Low Frequency Cut-off	LFCO			20		Hz
High Frequency Flatness		+3dB relative to @ 1KHz		10		kHz

Analog Bottom Mount MEMS Microphone

Electrical Key Characteristics and Performance

PARAMETER	SYMBOL	TEST CONDITION	VALUES			UNITS
			MIN	TYP	MAX	
Input / Supply Voltage	V _{DD}		1.5	2.5	3.3	V
Input current	I _{DD}	V _{DD} =1.5V-3.3V	90	115	130	μA
Output impedance	Z _{OUT}	94 dB SPL @ 1kHz, Single-ended output	-	-	200	Ohm
Power Supply Rejection	PSR	100mVpp Square wave @217Hz, A-weighted		-103		dBFS
Power Supply Rejection Ratio	PSRR	200mVpp sine wave at 1kHz, V _{DD} =1.8V		70		dB
DC output voltage	V _{OUT_DC}	V _{DD} =1.5V-3.3V, Single ended output		0.85		V
Start-up time	t _{Start}	Single-ended output		15		mS
Equivalent input noise	EIN	Noise measured with A- weighted filter		3		μV

TYPICAL FREQUENCY RESPONSE CURVE

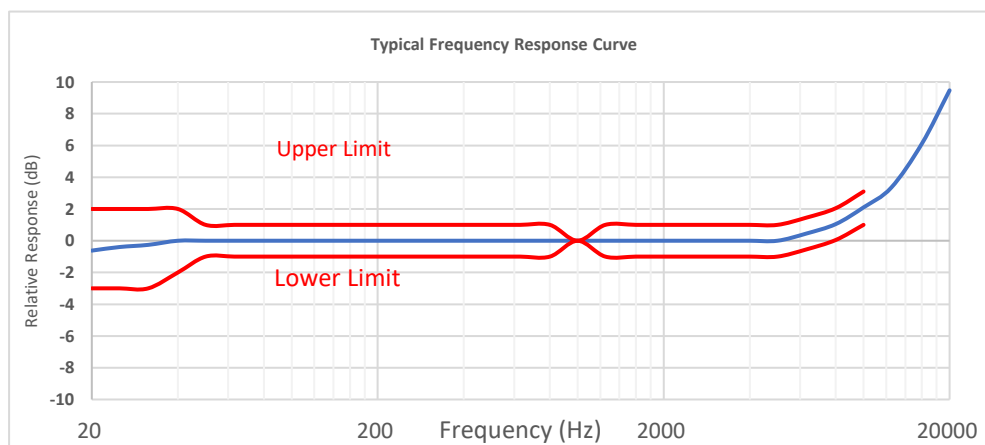

Analog Bottom Mount MEMS Microphone

PACKAGE DIMENSION AND PIN LAYOUT

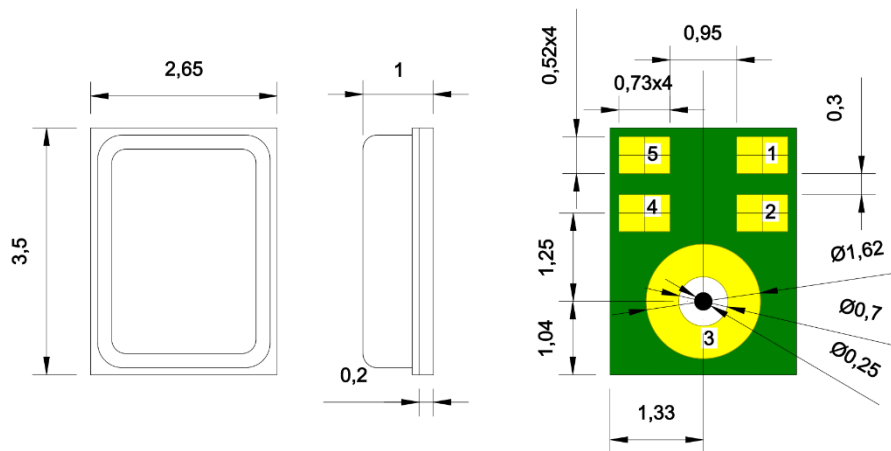

Item	Dimension	Tolerance(+/-)	Units
Length(L)	3.50	0.10	mm
Width(W)	2.65	0.10	mm
Height(H)	1.0	0.10	mm
Acoustic Port(AP)	Ø0.25	0.05	mm

Pin #	Pin Name	Type	Description
1	Output	Signal	Output Signal
2	GND	Ground	Ground
3	GND	Ground	Ground
4	NA	NA	NA
5	VDD	Supply	Power supply

Analog Bottom Mount MEMS Microphone

Terminology

1. **POWER:** The Supply Voltage Positive Terminal (Pad name "VDD" in Electrical layout drawing) which is connected to the Microphone Sensing Element.
2. **OUTPUT:** The Output Terminal, where the electrical signal equivalent to the acoustic pressure is available, i.e. the Microphone output. (Pad name "OUTPUT" in Electrical layout drawing)
3. **COMMON:** The Terminal where the supply negative (Pad name "GND" in Electrical layout drawing) is connected to microphone package.
4. **SENSITIVITY:** Sensitivity is the open circuit output voltage amplitude for a given sound pressure at the microphone diaphragm. This is frequency dependent so typically quoted at 1KHz. Units are defined in dB logarithmic scale.
5. **FREQUENCY RESPONSE:** It is the plot of Sensitivity in dB vs frequency [Hz], it depends on transducer mechanism directional response, and reflection from room boundaries – usually quote free-field response.
6. **DIRECTIVITY:** It is the response pattern that expresses the geometric shape of the region of sensitivity surrounding the microphone, omni directional, uni directional, bi- directional.

FUNCTIONAL BLOCK DIAGRAM

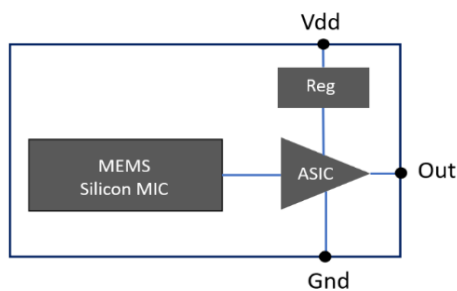

ELECTRICAL BLOCK DIAGRAM

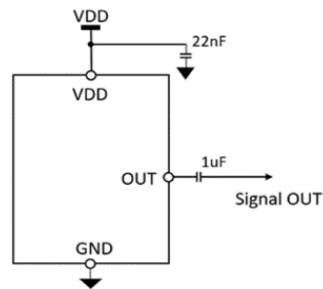

Analog Bottom Mount MEMS Microphone

Packaging Information

Tape & Reel Specification

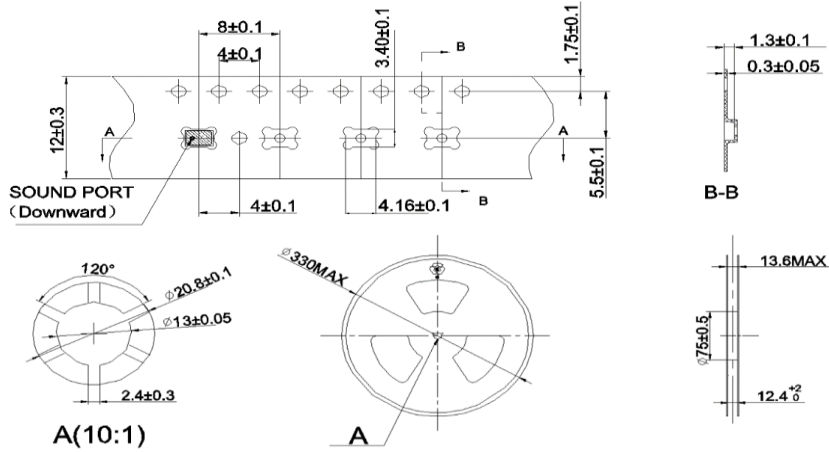

Packaging Information

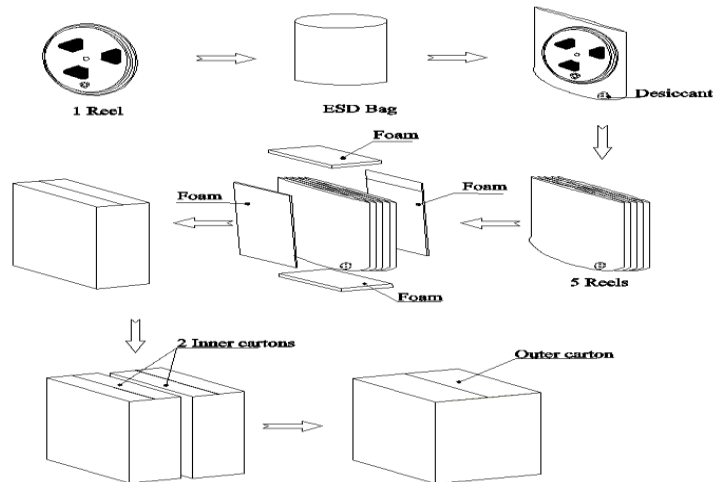

Packaging quantity:

1 Reel=5000pcs

1 Inner Carton =5Reels=25000pcs

1 Outer Carton=2 Inner Cartons=50000pcs

Analog Bottom Mount MEMS Microphone

PROCESSING INFORMATION

Recommended Reflow Process Condition:

Recommend reflow profile, solder reflow $\leq 260^{\circ}\text{C}$ (for 30s Max of peak temperature).

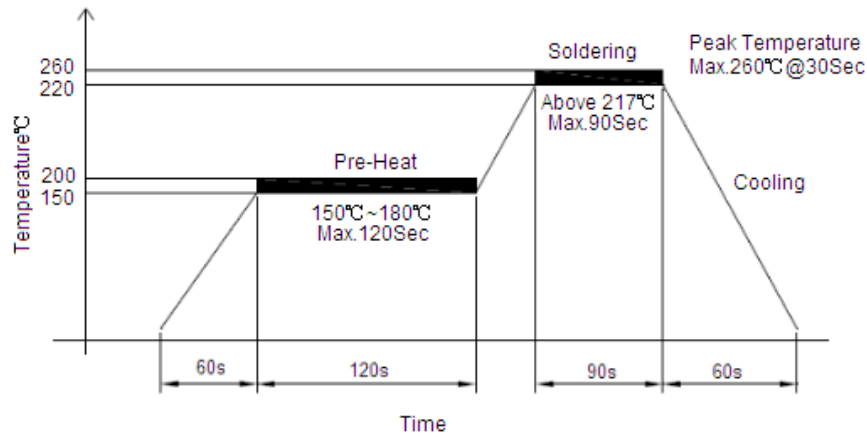

Important Notes

To minimize device damage:

- Do not wash or clean the boards after the reflow process.
- Do not apply airflow with pressure exceeding 0.3MPa to blow into the port hole within a distance of less than 5 cm.
- Do not expose the device to ultrasonic processing or cleaning.
- Do not apply a vacuum over the port hole of the microphone.

Pickup Tool Pick Location & PCB Solder Pad Layout:

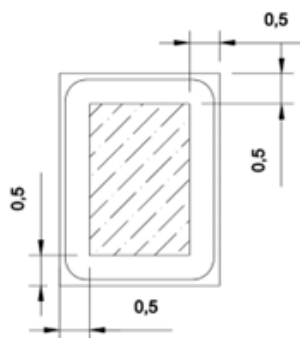

Recommended Pickup Location

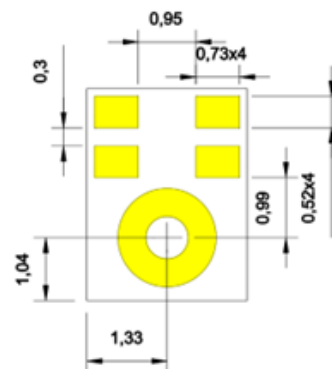

Recommended Solder Pad Layout

Analog Bottom Mount MEMS Microphone

TEST SETUP

Sensitivity Test in Anechoic Room

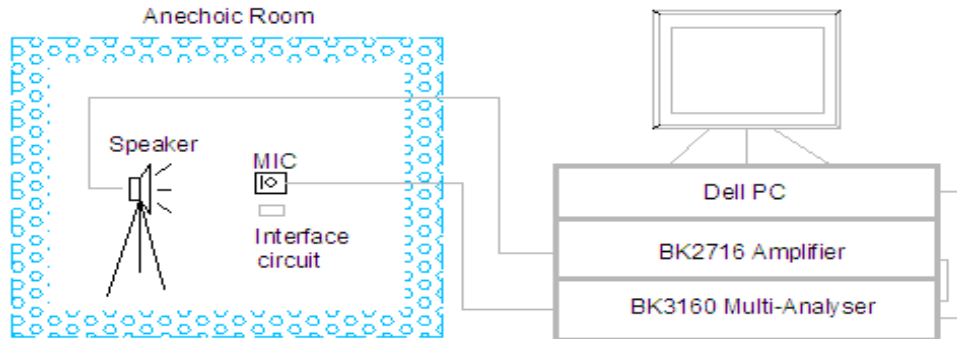

Measurement Circuit

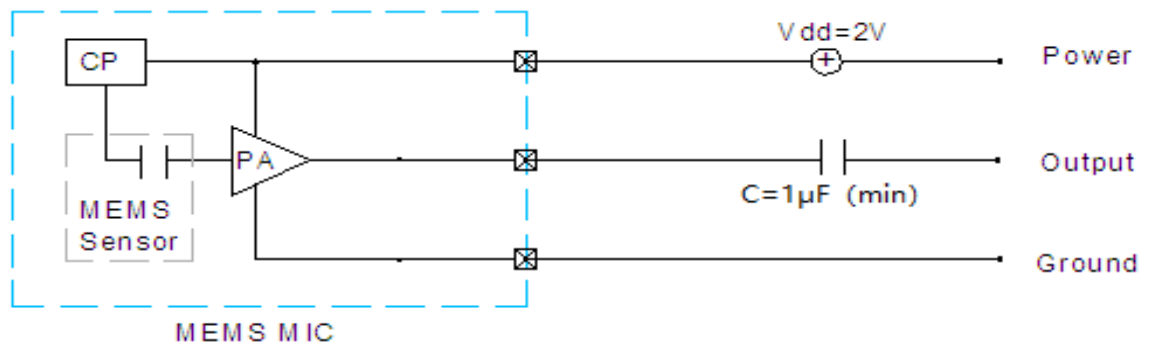

Analog Bottom Mount MEMS Microphone

RELIABILITY TEST

The samples should be placed in the room with 23+/-2°C, 55+/-10%R.H. for 2 hours at least before final measurement, unless otherwise specified.

Item	Detail	Standard
Simulated Reflow (Without Solder)	Samples for qualification testing require 3 Times 260±5 °C reflow solder profiles. 2 hours of settling time is required between each reflow profile test.	±3 dB
Static Humidity	Precondition at +25°C for 1 hour. Then expose to +85°C with 85% relative humidity for 1000 hours.	±3 dB
Temperature Shock	Each cycle shall consist of 30 minutes at -40°C, 30 minutes at +125°C with 5 minutes transition time. Test duration is for 30 cycles, starting from cold to hot temperature.	±3 dB
ESD Sensitivity	Perform ESD sensitivity threshold measurements for each contact according to MIL-STD-883G, Method 3015.7 for Human Body Model. Identify the ESD threshold levels indicating passage of 8000V Human Body Model.	±3 dB
Random Vibrations	Vibrate randomly along three perpendicular directions for 30 minutes in each direction, 4cycles from 20Hz~2000Hz with a peak acceleration 20g.	±3 dB
Mechanical Shock	Subject samples to half sine shock pulses (3000g±15% for 0.3ms) in each direction, totally 18 shocks.	±3 dB
Operation Life	Subject samples to +125°C for 168 hours under full maximum rated voltage.	±3 dB
Drop Test	The test was repeated in six directions for three times, Dropped from 1.5m height on to a steel surface, total 18 times and inspected for mechanical damage. Note: Sensitivity should vary within +/-3dB from initial sensitivity after test conditions are performed.	±3 dB

Delivery Standard:

- Product delivered with 100% testing.
- All parts are tested for sensitivity at 1KHz.
- Product samples tested for frequency curve and SNR.



Analog Bottom Mount MEMS Microphone

PRODUCT NAMING CONVENTION

Company name	Packaging size Length (mm) Width (mm)	Output A = Analog D = Digital	Mount T=Top Mount B= Bottom mount	Sensitivity -dB (V/Pa)	Noise dB	Status
IR Sensors &Systems						
IR	3526	A	B	38	68	Active

DOCUMENT HISTORY

Document Version	Date of Release	Changes
1.0	Feb. 15 th , 2024	Initial Version

Analog Bottom Mount MEMS Microphone

INTERNATIONAL CONTACT INFORMATION

Anu Austin
Phone number: +65 96235457
Email address:
anu.austin@irsensorssystems.com

INDIA

Memstech
Address: 83 A2, New no: 136 Bharathi Colony, 3rd Street,
Peelamedu, Coimbatore - 641 004, Tamilnadu, India
Branch office:
5/63 OMR Egattur Chennai - 600130, Tamilnadu, India
Phone number: +91 84898 13526
Email address:
guru@memstech.com

EUROPE

Dieter Naegele
Address: Heimesgasse19d, Ingelheim am Rhein-55218
Phone number: +4915253923397
Email address:
dieter.naegele@irsensorssystems.com

NORTH AMERICA

K. Sooriakumar
Address: 75 Boniface Drive
Rochester, NY 14620
Phone number: +1 585 7362223
Email address:
k.soori@irsensorssystems.com

Randy De Brine
Phone number: +1 585 7378922
Email address:
randy.debrine@irsensorssystems.com